

White Custom Deluxe Podium

Upscale Look, Enhanced Security, Electronics Ready

The White Custom Deluxe Podium comes with interchangeable panels that are available in hundreds of different custom laminate options, white acrylic and solid gloss colored acrylic. The White Custom Deluxe Podium panels are brand-able allowing you to add custom graphics and the panels slide in and out of the frame (just like a photo slides into a picture frame) allowing for quick signage installation.

Plus, there is an optional LED kit upgrade which makes the panels glow. The LED kit is powered by a rechargeable cordless battery system with an 8-hour charge cycle. If you need to light up the podium for longer than 8 hours, it can be plugged directly into an electrical outlet. The LED kit also comes with a remote operated controller which has multiple speed, brightness, and color settings. The included 8 colors options are: cyan, purple, white, orange, yellow, green, blue, and red.



Basic Features

- All steel construction – 16 gauge, heavy-duty sheet metal
- Counter with brushed stainless steel trim
- Tamper-proof locking security bar (padlock required)
- Locking anchor loop
- Tip box installed
- Electronics compatible with two covered cable inlets
- 50-200 key capacity
- Two-step zinc/ textured powder coat for outstanding weather resistance
- Key hooks w/ black, screen printed numbers
- Zinc hardware
- Brushed stainless steel working surface
- Umbrella holder
- 2 Locking, 2 non-locking Heavy-duty casters
- 2 Metal slam-action locks with 2 keys
- Tip slot
- Replaceable parts
- Pre-assembled
- Manufacturer's Warranty

Dimensions: 36.5"W x 24"D x 49"H

Weight: 140 lbs.

Interior Upgrades

Door Lock

Combination Lock + \$85.00

Simplex Pushbutton Combination + \$320.00

Schlage Keypad Lock + \$450.00

Key hooks

100 + \$60.00

150 + \$120.00

200 + \$180.00

Short Shelf + \$30.00

Long Shelf + \$55.00

Exterior Upgrades

Counter Trim Color (Stainless or White)

Curved Counter + \$50.00

Laminate Panels + \$835.00

LED Kit (No Battery) + \$160.00

LED Kit + \$435.00

Artwork Upgrades

Vinyl Print + FROM \$285.00

LED Sign \$1,350.00

Accessories

Podium Cover + \$80.00

Heavy Duty Podium Cover + \$115.00

Valet Umbrella + \$255.00

Valet Flap Umbrella + \$300.00

Key Fob Pouch + \$35/ pack of 10

Key Fob Pouch - RFID Protection
+ \$25 / pack of 5



with curved counter & laminate panel upgrades

White Custom Deluxe Podium in Rediscovered Oak Planked Laminate Panels



Laminate Options



Jubilee Oak



French Pear



Ashbee Oak



White Driftwood



Antique Marula
Pine

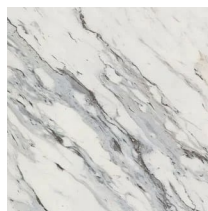

Calcutta Marble



Brazilian Grey

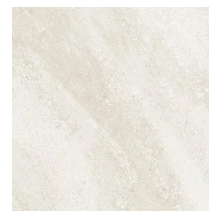

Beachwalk

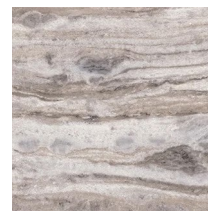

Glacier Quartzite

More laminate options available at [Wilsonart](https://www.wilsonart.com).
Contact us for Pricing, Availability and Delivery Times.

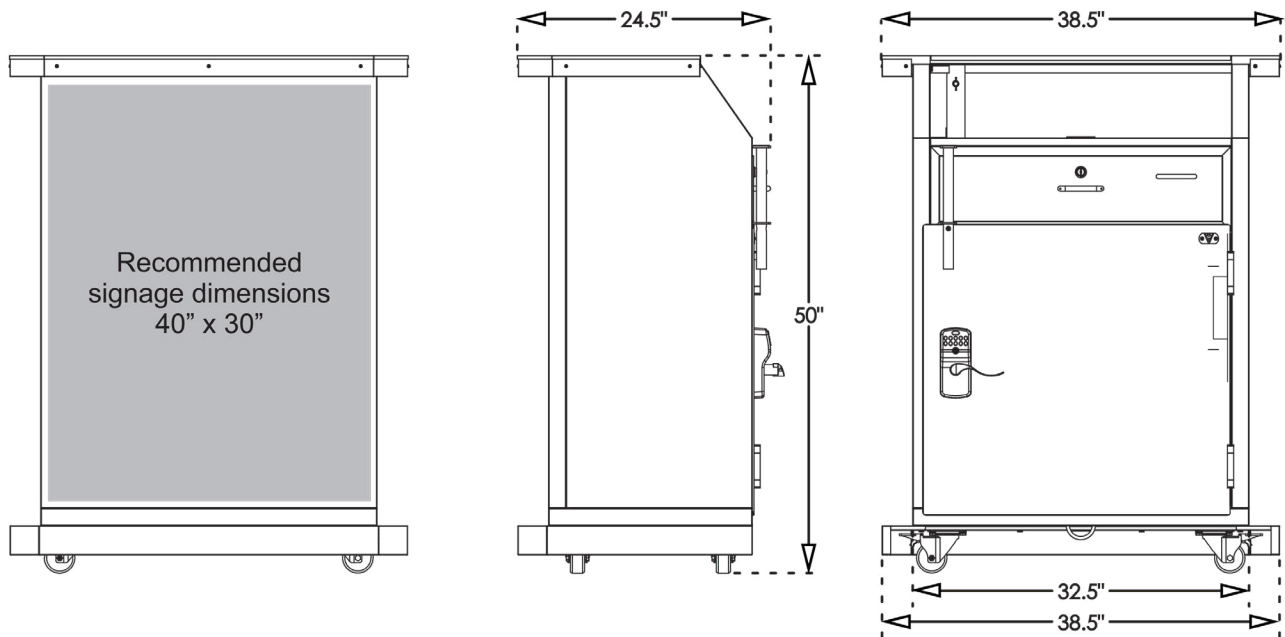
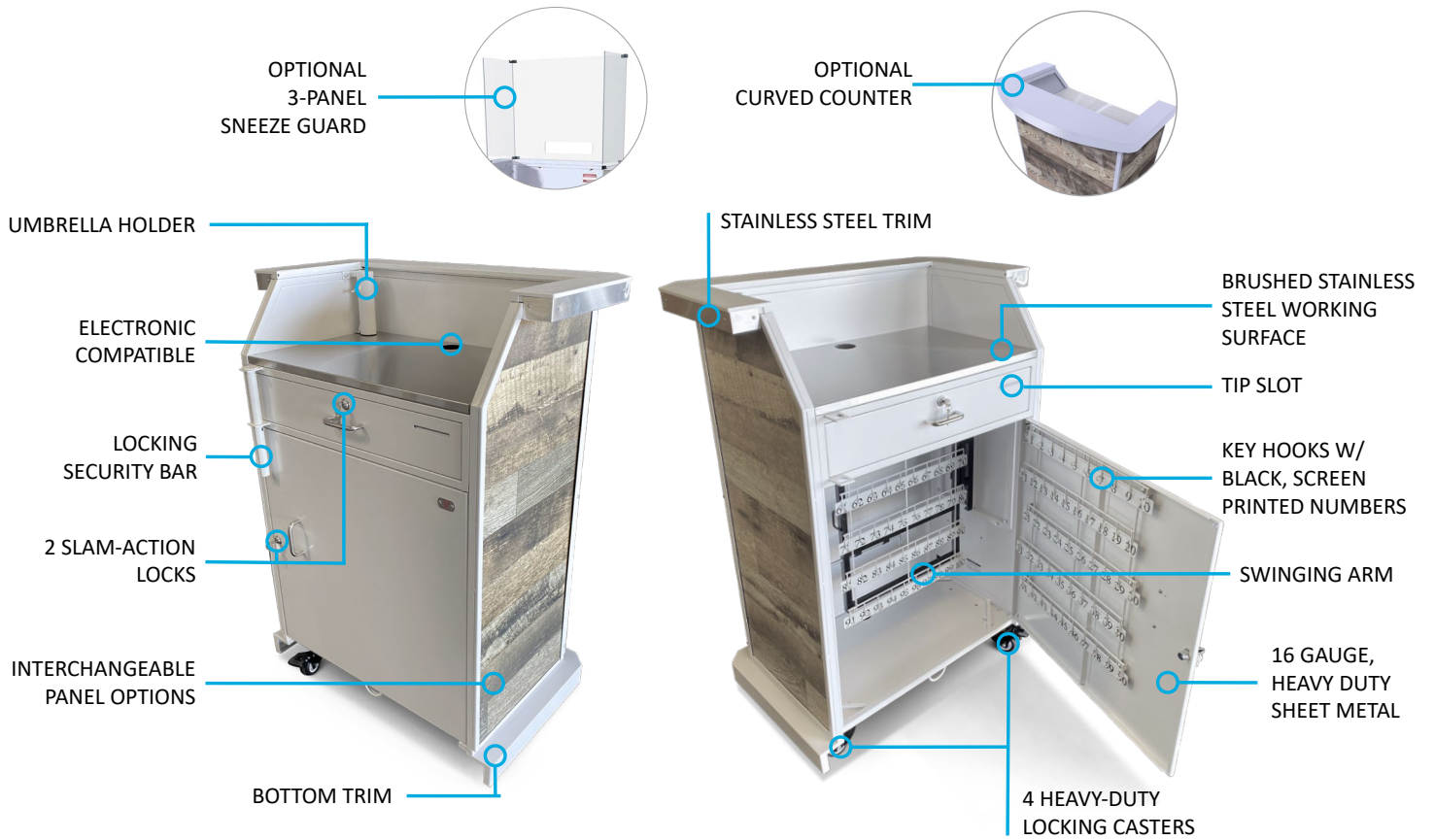

**TOTAL COST
BEFORE DELIVERY**

\$2,150 (basic options)

LED Sign for Custom Deluxe Podium

Our LED signs are comprised of clear acrylic with three types of design application: Laser-cut laminate, Etched acrylic, and Printed acrylic. The design application will ultimately be determined by the complexity of the logo provided.

Choose from Black, White, or Milwaukee JCT Oxide for the sign laminate.



Laser-cut laminate

Best for simple designs with thicker linework in one or two colors.



Etched acrylic

Best for more complex logos with fine linework – can be mixed with laser-cut portions to increase visibility and add visual interest.



Printed acrylic

Best for multicolored logos and use with or without LEDs.



The strong, professional look of the custom LED backlit sign is enhanced when the sign is mounted to your Custom Professional Kiosk with 1.5" silver stand-offs. The look is completed with remote-controlled, color-changing LED lighting that creates a "halo" effect on your sign.

The LED kit is powered by a rechargeable cordless battery system with an 8-hour charge cycle. If you need to light up the station for longer than 8 hours, it can be plugged directly into an electrical outlet. The LED kit also comes with a remote operated controller which has multiple speed, brightness, and color settings.

LED Kit includes

- 8 Color options: Red, Orange, Yellow, Blue, Cyan, Purple, White Green
- Waterproof LED strips with multiple color options
- Sealed, 8 hour rechargeable battery w/ power supply
- Easy-to-use controller and remote

Available only on Custom Deluxe and Custom Professional Kiosk
Sign sizing: 16"x24"



Don't want it backlit? Ask us for pricing on a sign without LEDs.

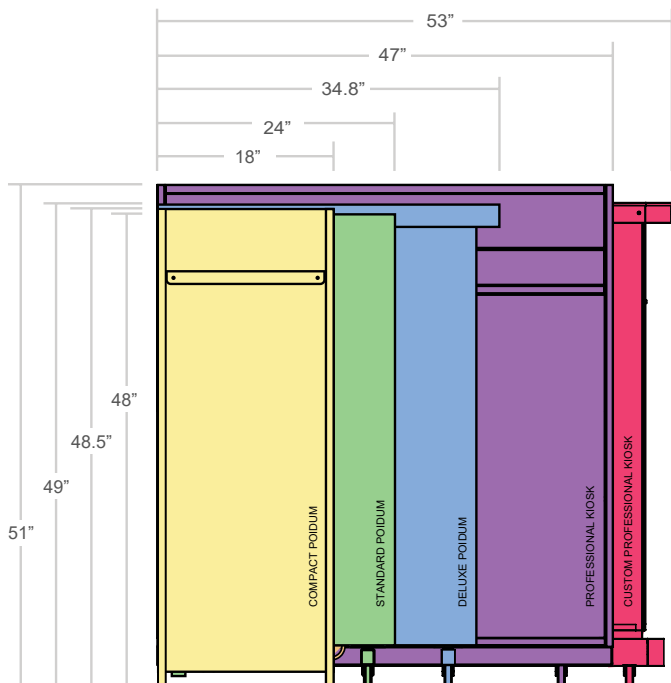

	Slam Lock / Cam Lock	Combination Cam Lock	Simplex Pushbutton	SCHLAGE FE595
Compact Podium	✓	✓		
Standard Podium (Black & White)	✓	✓	✓	✓
Deluxe Podium	✓	✓	✓	✓
White Deluxe Podium	✓	✓		✓
Custom Deluxe Podium	✓	✓	✓	✓
White Custom Deluxe Podium	✓	✓		
Heavy Duty Deluxe Podium				✓
Professional Kiosk (Black & White)	✓	✓		✓
Custom Professional Kiosk (Black & White)	✓			✓



Slam Lock

Standard lock with key. Locks automatically when door is closed. Reliable, fast and secure.



Simplex Pushbutton Combination Lock

Keyless entry. Push in the combination to access. Locks automatically when door is closed. Fast keyless entry, resettable combination, no keys to manage.

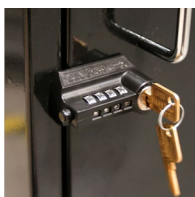

Combination Cam Lock

Access with the master key or dial in the 4 digit combination. Must be manually locked and does not have the ability to be "slam locked". Resettable combination



SCHLAGE FE595 Keypad Entry

Convenient and secure keyless access which locks automatically when door is shut. Program up 19 user codes to fit your security needs. Battery operated key pad lights up for visibility at night. 3 year battery life.



Key Cam Lock

Cam lock needs to be manually locked. Option for keyed alike and keyed different.